

H =  
 Altura máxima bajo gancho sin arriostrar (m).  
 Maximum height under hook without fastening (m).  
 Hauteur maximale sous crochet sans ancrage (m).  
 Максимальная высота под крюком без крепления (m).  
 Bağlantısız maksimum kanca altı yüksekliği (m).  
 أقصى ارتفاع تحت الخطاف بدون ربط (m)

PC19-1	163.40.000	BSRI 8-20-5,6	204.20.000
PC19-2	163.41.000	BRI 10-24	156.20.500
PC19-33	163.42.500	ASR20	160.21.200
PC19-34	163.43.500	ASRD 20/24	156.21.000
PT19-35	163.44.500	TSR20	153.31.800
PT19-36	163.45.500	TR24/TSR20	204.36.000
PT19-37	163.46.500	TR24-5,6	156.30.700
PT19-8	163.47.000	TRD24-5,6	163.31.300
PT19-39	163.48.200	TM20PASR-5,6	206.35.000
PP19	163.48.500	ABH100B	204.23.000
		ABH100H	156.23.500

(H) TRASLACIÓN / TRAVELLING /  
 TRASLACION / ПЕРЕМЕЩЕНИЕ / RAY YÜRÜYÜŞLÜ / متحركة

(H) ESTACIONARIA / STATIONARY /  
 STATIONAIRE / СТАЦИОНАРНОЕ СОСТОЯНИЕ / SABIT / ثابتة

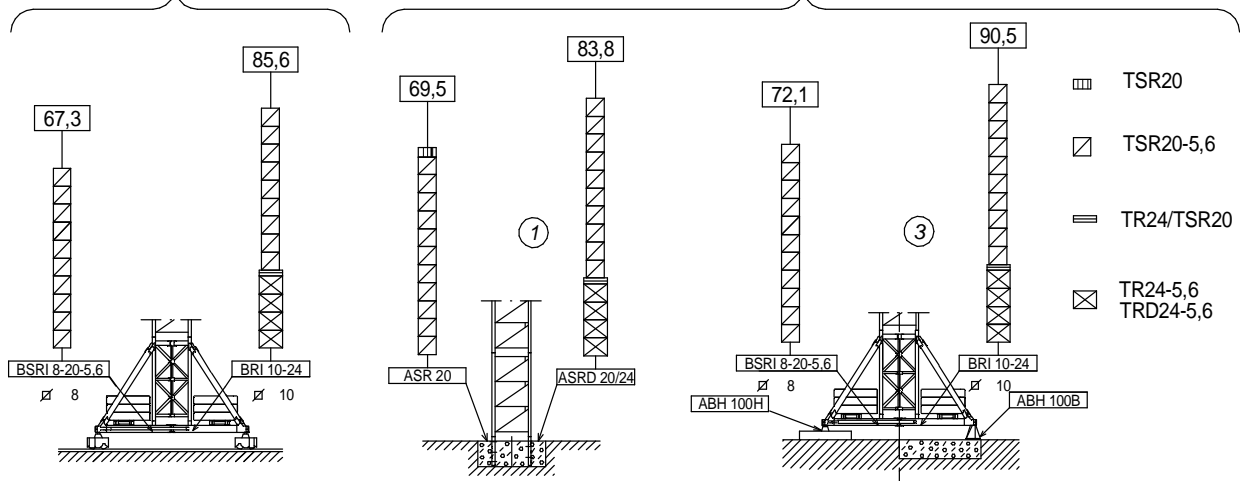

Fecha / Date: 23/04/2018

ST-SR (t)		Cargas máximas / Maximum loads / Charges maximales / Максимальные нагрузки / Maksimum yük / أقصى حمولة ST-SR – 12 t													
[m]	12 t @ ... (m)	Alcance del gancho [m] / Hook reach [m] / Portée du crochet (m) / Радиус действия крюка (m) / Kancanın yüksekliği (m) / مدى الخطاف													
		25	30	35	40	45	50	55	60	65	70	75	80	85	
85	27,6	12,00	10,87	9,02	7,64	6,56	5,70	4,99	4,40	3,90	3,48	3,11	2,78	2,5	
80	31,7	12,00	12,00	10,66	9,07	7,83	6,84	6,03	5,36	4,78	4,29	3,87	3,50	—	
75	35,0	12,00	12,00	12,00	10,25	8,88	7,78	6,89	6,14	5,51	4,97	4,50	—	—	
70	37,7	12,00	12,00	12,00	11,17	9,70	8,53	7,56	6,76	6,08	5,50	—	—	—	
65	44,2	12,00	12,00	12,00	12,00	11,75	10,37	9,24	8,30	7,50	—	—	—	—	
60	45,1	12,00	12,00	12,00	12,00	12,00	10,61	9,46	8,50	—	—	—	—	—	
55	49,1	12,00	12,00	12,00	12,00	12,00	11,76	10,50	—	—	—	—	—	—	
50	50,0	12,00	12,00	12,00	12,00	12,00	12,00	—	—	—	—	—	—	—	
45	45,0	12,00	12,00	12,00	12,00	12,00	—	—	—	—	—	—	—	—	
40	40,0	12,00	12,00	12,00	12,00	—	—	—	—	—	—	—	—	—	
35	35,0	12,00	12,00	12,00	—	—	—	—	—	—	—	—	—	—	
30	30,0	12,00	12,00	—	—	—	—	—	—	—	—	—	—	—	

ST - DR [t]		Cargas máximas / Maximum loads / Charges maximales / Максимальные нагрузки / Maksimum yük / أقصى حمولة ST - DR – 24 t													
[m]	24 t @ ... [m]	Alcance del gancho [m] / Hook reach [m] / Portée du crochet (m) / Радиус действия крюка (m) / Kancanın yüksekliği (m) / مدى الخطاف													
		20	25	30	35	40	45	50	55	60	65	70	75	80	85
85	14,8	17,03	13,10	10,48	8,60	7,20	6,11	5,24	4,52	3,93	3,42	2,99	2,62	2,29	2,0
80	16,9	19,87	15,37	12,37	10,23	8,62	7,37	6,37	5,56	4,87	4,30	3,80	3,37	3,00	—
75	18,7	22,21	17,25	13,93	11,57	9,79	8,42	7,31	6,41	5,66	5,02	4,47	4,00	—	—
70	20,0	24,00	18,72	15,16	12,62	10,72	9,23	8,05	7,08	6,27	5,59	5,00	—	—	—
65	23,5	24,00	22,40	18,23	15,25	13,01	11,28	9,89	8,75	7,80	7,00	—	—	—	—
60	23,9	24,00	22,87	18,62	15,59	13,31	11,54	10,12	8,97	8,00	—	—	—	—	—
55	26,1	24,00	24,00	20,52	17,21	14,73	12,80	11,26	10,00	—	—	—	—	—	—
50	26,5	24,00	24,00	20,92	17,55	15,03	13,07	11,50	—	—	—	—	—	—	—
45	26,7	24,00	24,00	21,11	17,72	15,18	13,20	—	—	—	—	—	—	—	—
40	27,2	24,00	24,00	21,54	18,09	15,50	—	—	—	—	—	—	—	—	—
35	27,2	24,00	24,00	21,55	18,10	—	—	—	—	—	—	—	—	—	—
30	27,3	24,00	24,00	21,60	—	—	—	—	—	—	—	—	—	—	—

LASTRES INFERIORES / LOWER BALLASTS / LESTS INFÉRIEURS / НИЖНИЙ БАЛЛАСТ / ALT AĞIRLIK TAŞLARI / ثقل				J560
BRI 10-24	H (m)	80,0	85,6	90,5
	P (t)	72	84	96
BSRI 8-20-5,6	H (m)	56,2	61,8	72,1
	P (t)	96	108	120

H: Altura bajo gancho / Height under hook / Hauteur maximale sous crochet Высота под крюком / Kanca altı yüksekliği / الارتفاع أسفل الخطاف  
 Para alturas intermedias tomar el lastre correspondiente a la altura superior / For intermediate heights take the ballast corresponding to the higher height / Pour les hauteurs intermédiaires, opter pour le lest correspondant à la hauteur immédiatement supérieure / Для промежуточных высот возьмите балласт, соответствующий большей высоте / Orta yükseklikler için daha üst bir yüksekliğe karşılık gelen ağırlığı alınız. / للارتفاعات البينية يرجى استخدام الثقل العائد للارتفاع الأعلى / Orta yükseklikler için daha üst bir yüksekliğe karşılık gelen ağırlığı alınız.

TREPADO / CLIMBING / TÉLESCOPAGE / ЛЕСТНИЦА / TIRMANMA / التسلق J560

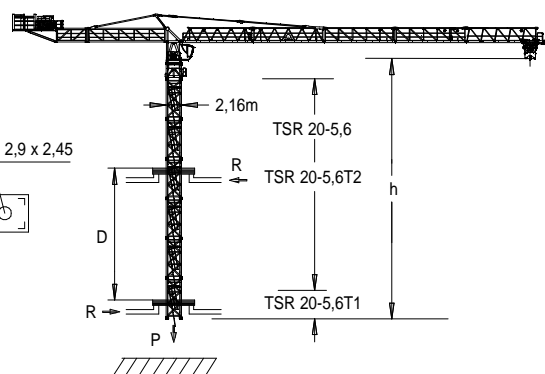

$$h_{max} = \text{TSR20-5,6T1} + 8 \times \text{TSR20-5,6} + \text{TSR20-5,6T2}$$

h (m)	60
D (m)	13,4 – 28,4
P (KN)	1965 / 1725
Rmax (KN)	425 / 805

TSR20-5,6T1: 204.31.600  
 TSR20-5,6T2: 204.31.900











Trepado interno / Internal climbing. / Télescopage intérieur / Внутренняя лестница / Bina içi tırmanma / التسلق الداخلي

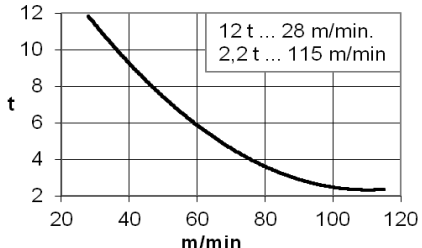
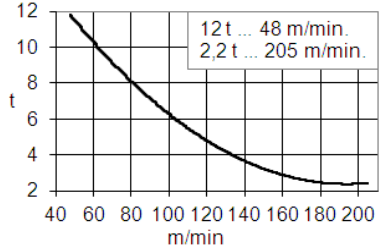
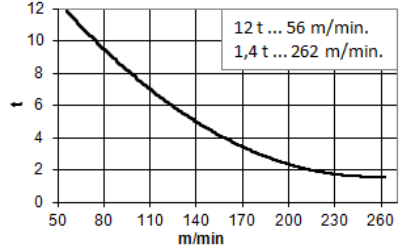

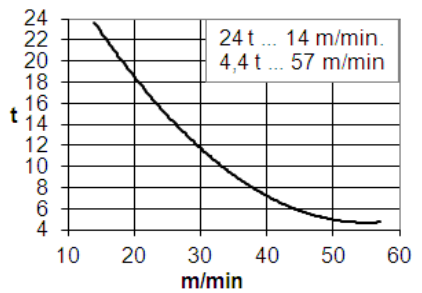
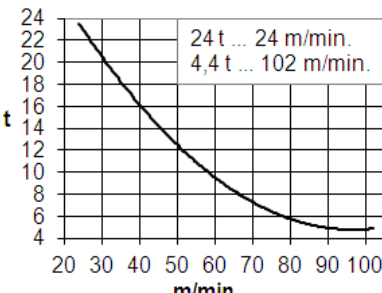
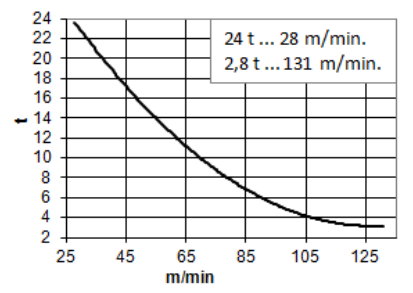
Fecha / Date: 23/04/2018

FEM 1001

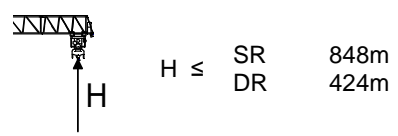

Reservado el derecho a modificaciones sin previo aviso. Declinamos toda responsabilidad derivada de la información proporcionada / Subject to modification, without previous warning. This information is supplied without liability / L'entreprise se réserve le droit de procéder à des modifications sans préavis. Nous déclinons toute responsabilité quant aux informations fournies / Мы оставляем за собой право на внесение изменений без предварительного уведомления. Мы снимаем с себя любую ответственность в отношении предоставленной информации / Önceden bildirilmeksizin değiştirilme hakkı saklıdır. Verilen bilgiler için hiçbir sorumluluk kabul etmemekteyiz / حقوق التغيير محفوظة دون إشعار مسبق. دون أدنى مسؤولية عن المعلومات المقدمة

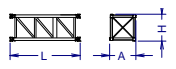
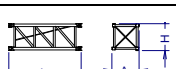
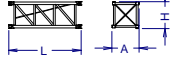
*opcional *optional *en option *опция *opsiyonel *اختياري				
	<b>EC88115VF</b> <b>65 kW</b>	<b>*EC150205VF</b> <b>110 kW</b>	<b>*EC180262VF</b> <b>132 kW</b>	
				
				
				 400V 50Hz
<b>TG4025VF</b> 4 x 7,5 kW	<b>OG4006VF</b> 4 x 7,5 kW	<b>TC15105VF</b> 11 kW	<b>TH4010</b> 29,4 kW	<b>P<sub>TOTAL</sub> (EC88115VF + OG4006VF + TC15105VF) = 106 kW</b> <b>P<sub>TOTAL</sub> (EC150205VF + OG4006VF + TC15105VF) = 151 kW</b> <b>P<sub>TOTAL</sub> (EC180262VF + OG4006VF + TC15105VF) = 173 kW</b>
0...25 m/min	0...0,8 r/min sl/min	$\frac{12t}{0...105}$ m/min $\frac{24t}{0...52}$ m/min	0,6 m/min	

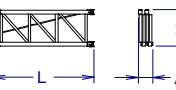
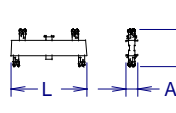
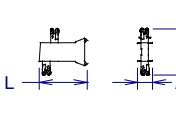



<b>LISTA DE EMBARQUE / PACKING LIST / LISTE DE COLISAGE СПИСОК ПОСТАВКИ / ÇEKİ LİSTESİ / قائمة التحميل</b>					<b>J560</b>			
DENOMINACIÓN / DENOMINATION / DÉSIGNATION / НАЗВАНИЕ / AÇIKLAMA / اسم			L [m]	A [m]	H [m]	P / W [kg]		
Torre inferior / Lower tower / Tour inférieure / Нижняя башня Alt kule / البرج السفلي			TSRI-20-5,6		5,990	2,257	2,257	6860
			TRID24-5,6		5,990	3,203	3,203	8400
Torre / Tower / Tour Башня / Kule / برج			TSR20		4,260	2,251	2,251	3110
			TSR20-5,6		5,990	2,257	2,257	4210
			TR24-5,6		5,990	2,760	2,835	4760
Torre desmontada / Dismantled tower / Tour démontée / Разобранная башня / Kule demonte edilmiş / برج مفكك			TRD24-5,6		5,990	1,170	2,545	5280
Larguero largo, reducción / Long crossbar, reduction / Traverse longue, réduction / Длинная продольная балка, уменьшение / Uzun kiriş, azaltma عارضة طويلة، مُصغر			TR24/TSR20		3,950	0,6	1,814	2267
Larguero corto reducción / Short crossbar, reduction, Traverse courte, réduction / Короткая продольная балка, уменьшение / Kısa kiriş, arttırma عارضة قصيرة، مُصغر			TR24/TSR20		1,915	0,6	1,814	1058

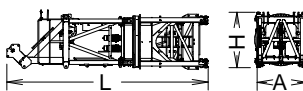
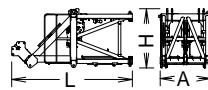
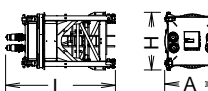
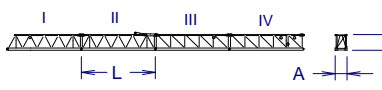
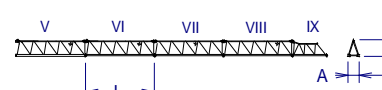
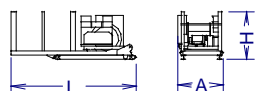
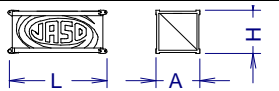
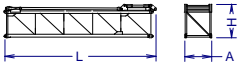

Fecha / Date: 23/04/2018

 FEM 1001

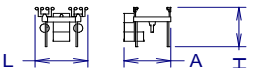
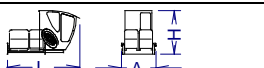
Reservado el derecho a modificaciones sin previo aviso. Declinamos toda responsabilidad derivada de la información proporcionada / Subject to modification, without previous warning. This information is supplied without liability / L'entreprise se réserve le droit de procéder à des modifications sans préavis. Nous déclinons toute responsabilité quant aux informations fournies / Мы оставляем за собой право на внесение изменений без предварительного уведомления. Мы снимаем с себя любую ответственность в отношении предоставленной информации / Onceden bildirilmeksizin değiştirilme hakkı saklıdır. Verilen bilgiler için hiçbir sorumluluk kabul etmemekteyiz / حقوق التغيير محفوظة دون إشعار مسبق. دون أدنى مسؤولية عن المعلومات المقدمة

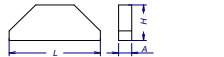
Torre asiento pista, torre superior y orientación Slewing table, top tower and slewing mechanism Tour pivot + tour supérieure + mécanisme d'orientation Сиденье площадки + верхняя башня + поворотный механизм Göbek + üst kule + mekanizma برج وحدة الدوران + البرج العلوي + آلية الدوران			8,900	2,320	2,480	16900
Punta de torre / Top tower / tour supérieure / верхняя башня / Kulenin kafa bölümü / رأس البرج			5,120	2,440	2,140	4950
Torre asiento pista + base punta de torre + orientación Slewing table + tower head base + slewing mechanism Tour pivot + base du porte-flèche + mécanisme d'orientation Сиденье площадки + основание верхней секции башни + поворотный механизм Göbek + üst kule + mekanizma برج وحدة الدوران + البرج العلوي + آلية الدوران			4,660	2315	2,460	11950
Tramo de pluma Jib section Tronçon de flèche Секция стрелы Вот bölümü أجزاء الذراع	PC19-1		10,270	1,845	2,235	4215
	PC19-2+tr		10,300	1,600	2,400	5385
	PC19-33		10,280	1,600	2,175	4930
	PC19-34		10,280	1,600	2,175	4125
	PT19-35		10,315	1,600	2,205	2745
Tirante sostén pluma / Jib support tie / Tirant de fleche / Растяжка поддержки стрелы / Kol destek bağları / مشد دعامة الذراع	PT19-36		10,300	1,600	2,205	2085
	PT19-37		10,280	1,600	2,160	1710
	PT19-8		10,280	1,600	2,160	1362
	PT19-39		5,184	1,600	2,163	770
	PP19		1,300	1,850	0,655	320
Contrapluma III con mecanismos (sin cable) y plumín auxiliar Counterjib III with mechanism (without rope), and auxiliary jib Contre-flèche III avec mécanisme (sans cable) et fléchette auxiliaire Противовесная консоль III с механизмами (без троса) и вспомогательной дополнительной стрелой Mekanizmalı kuşruk III (kablesiz) ve yardımcı bot uzantısı الذراع المعاكس III مع آليات (بدون كابل) وريشة مساعدة			6,395	2,300	2,456	9620
Contrapluma II / Counterjib II / Contre-flèche II / Противовесная консоль II / Kuşruk II / المعاكس II			4,550	2,034	2,064	2240
Contrapluma I / Counterjib I / Contre-flèche I / Противовесная консоль I / Kuşruk I / المعاكس I			11,420	2,034	2,505	9160
Polipasto / Hook assembly / Palan / Полуспаст / Kanca takımı / بكرة	ST/DR		1,750	0,650	1,340	1040
Carro / Trolley / Chariot / Грузовая тележка / Şaryo / عربة	ST/DR		2,580	2,305	2,135	1155
Plataforma y cabina / Platform and cabin / Plateforme et cabine / Платформа и кабина / Platform ve kabin / منصة وكابينة			3,670	2,300	2,480	1250
Transporte torre de montaje/ Jacking cage transport / Transport de tour de montage / Транспортировка монтажной башни / Kaldırma kafesinin taşınması / نقل برج التركيب		TM20PASR-5,6 	10,820	2,285	2,395	12140
Contrapeso / Counterweight / Contrepoids / Противовес / Denge اوزان معاكسة / اوزان معاكسة / Lastre / Ballast / Lest / Балласт Alt ağırlık taşları / ثقل			3,800	0,580	1,500	6000
			3,800	0,275	1,500	3000
			3,800	0,180	1,500	2000

 Viento fuera de servicio / Out of service wind / Vitesse du vent hors service / Ветровая нагрузка в покое / Rüzgar devre dışı / الريح خارج الخدمة

 Consultar / Consult / Nous consulter / Консультируетесь / Danışınız / الرجوع إلى

 En servicio / In service / En service / В работе / Devrede / في الخدمة

 Fuera de servicio / Out of service / Hors service / В покое / Devre dışı / خارج الخدمة



Ctra./Rd. Madrid - Irún Km. 415 - 20.213 IDIAZABAL [Gipuzkoa] ESPAÑA / SPAIN  
P.O. Box, 23 - 20.200 BEASAIN - E-mail: jaso@jaso.com  
Tel. +34 943 - 18 70 00 • Fax. +34 943 - 18 70 20  
**www.jaso.com**

Fecha / Date: 23/04/2018

 **FEM 1001**

DELEGACION / DEALER

Reservado el derecho a modificaciones sin previo aviso. Declinamos toda responsabilidad derivada de la información proporcionada / Subject to modification, without previous warning. This information is supplied without liability / L'entreprise se réserve le droit de procéder à des modifications sans préavis. Nous déclinons toute responsabilité quant aux informations fournies / Мы оставляем за собой право на внесение изменений без предварительного уведомления. Мы снимаем с себя любую ответственность в отношении предоставленной информации / Önceden bildirimlemeden değiştirilme hakkı saklıdır. Verilen bilgiler için hiçbir sorumluluk kabul etmemekteyiz /

حقوق التغيير محفوظة دون إشعار مسبق. دون أدنى مسؤولية عن المعلومات المقدمة